

PADDINGTON

Rain Water Solutions (Pty) Ltd

KZN



Manufacturers of premium aluminium gutters, downpipes, and accessories.



www.paddingtongutterskzn.co.za

COMPANY OVERVIEW



Founded in 2012 in Pinetown, KwaZulu-Natal, Paddington Rain Water Solutions was built on a simple promise: good service, good product, and good price.

What started as a focused gutter component supply business has grown alongside our customers, expanding into a broader range of products and solutions to support installers and contractors at every stage.

We proudly supply everyone from independent installers to large-scale operations, building long-term partnerships based on reliability and trust.



- ✓ Quality You can TRUST
- ✓ Service You can RELY on
- ✓ Pricing that makes SENSE



FASCIAS & BARGES



GUTTERCOIL & ACCESSORIES

Colours Available

- | | |
|--|---|
|  Anthracite Black |  Royal Brown |
|  Marble White |  Dove Gray |
|  Forest Green |  Charcoal Grey |
|  Rich Ivory | |

AA3003 H44 aluminium

0.6mm Coils
285mm
355mm

0.8mm Coils
448mm
600mm
925mm
1000mm

* In-house coil slitting available to meet your specifications



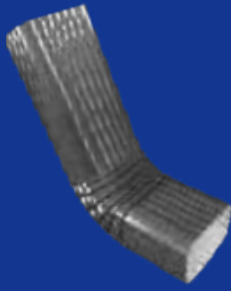

Domestic
75 x 50

Industrial
100 x 75

A2 Elbow



Domestic
75 x 50

Industrial
100 x 75

A1 Elbow

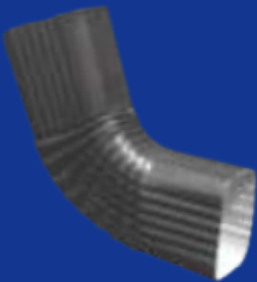

Domestic
75 x 50

Industrial
100 x 75

B Style Right

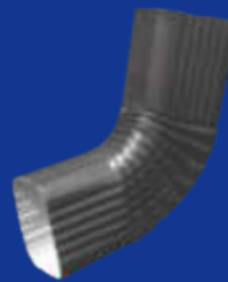

Domestic
75 x 50

Industrial
100 x 75

B Style Left



Domestic
125 x 80

Industrial
150 x 100

End Cap Right



Domestic
125 x 80

Industrial
150 x 100

End Cap Left

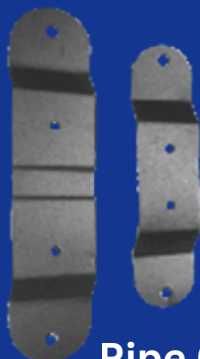

Domestic
75 x 50

Industrial
100 x 75

Pipe Cleats



Domestic
75 x 50

Industrial
100 x 75

Pipe Straps



Int Bay Mitre

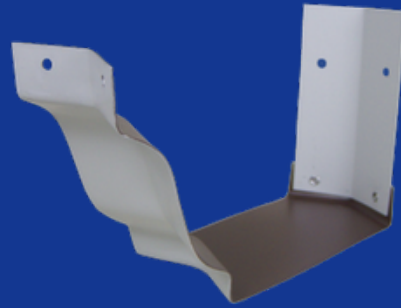

Ext Bay Mitre

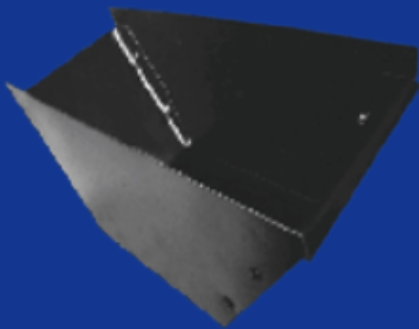

Funnel

300 x 230 x 230

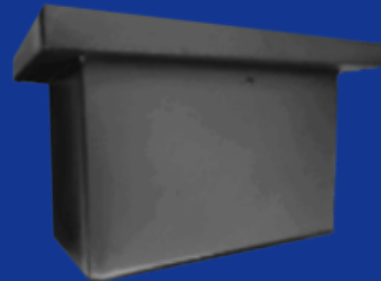

Hopper Box (RWH)

600 x 190 x 240

450 x 190 x 240

300 x 190 x 240

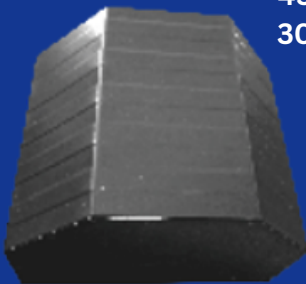

Hopper Box (RWH)



Gutter Bracket

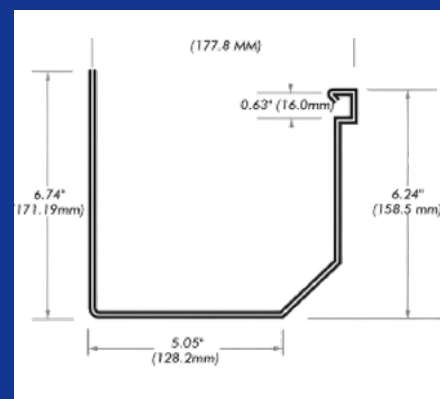
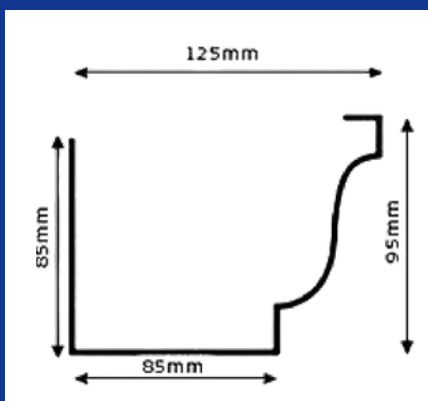

1 Piece Offset from
30mm to 200mm



Offsets

Domestic
125 x 80

Industrial
150 x 100

Custom offsets on request

Domestic
75 x 50

Industrial
100 x 75

**Down
Pipe &
Shoe**



Domestic
75 x 50

Industrial
100 x 75

**Plain
Down
Pipe**

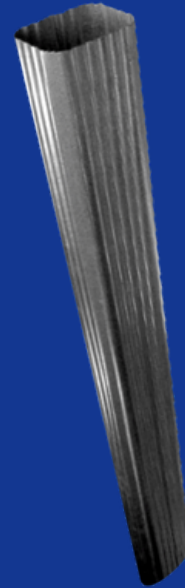

EXTERNAL CORNER FLASHING Girth = 462		GABLE TRIM Girth = 462	
SIDEWALL FLASHING Girth = 308		RIDGE CAPPING Girth = 462	
UNDERTILE FLASHING Girth = 308		INTERNAL CORNER FLASHING Girth = 462	
APEX FLASHING Girth = 462		HEADWALL FLASHING Girth = 308	
COUNTER FLASHING Girth = 154		COVER FLASHING Girth = 130	
DRIP FLASHING Girth = 154		VALLEY LINING Girth = 462	

MACHINES NEW/PRE OWNED

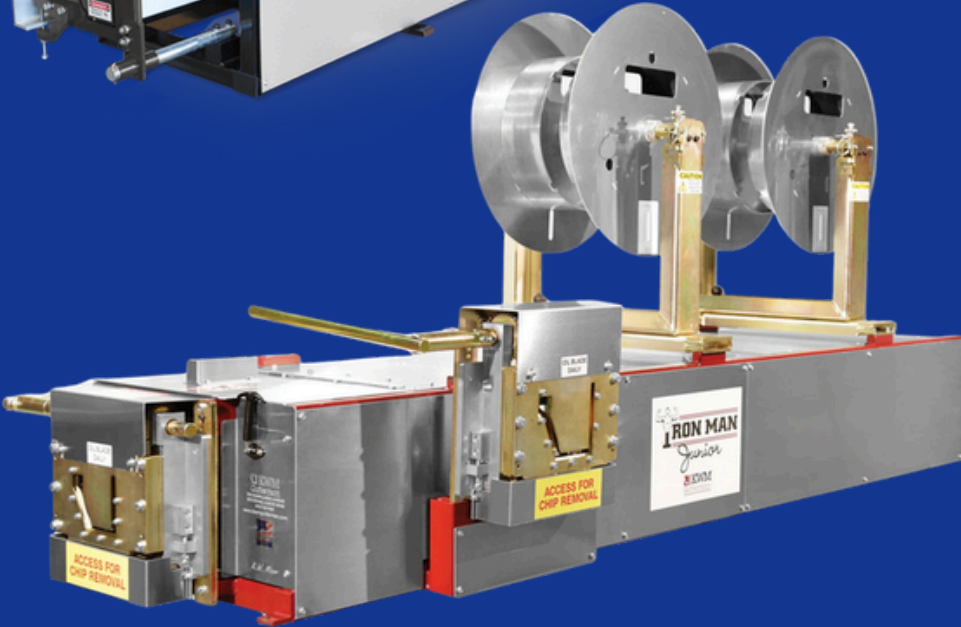

Trusted importers and distributors of three of the most popular gutter machines in the USA: KWM Gutterman, New Tech Machinery, and Grover Machines.

CLEANING & MAINTENANCE

AKC Gutter Cleaner

A powerful, easy-to-use solution that restores gutters, solar panels, roofing, and exterior surfaces to a clean, like-new finish.





CONTACT US



+27 31 702 6558



Doug@alugutters.com

Lee@alugutters.com



Unit 9, Riverdale Industrial Park

18 Dawnhill Road, Maxmead

Pinetown, 3610



www.paddingtongutterskzn.co.za

OTHER BRANCHES

GAUTENG

+27 11 616 1627

jhborders@alugutters.co.za

EASTERN CAPE

+27 46 624 1521

gutters@paddington.co.za